

PRELIMINARY SPEC

L-7701C4SURC-G

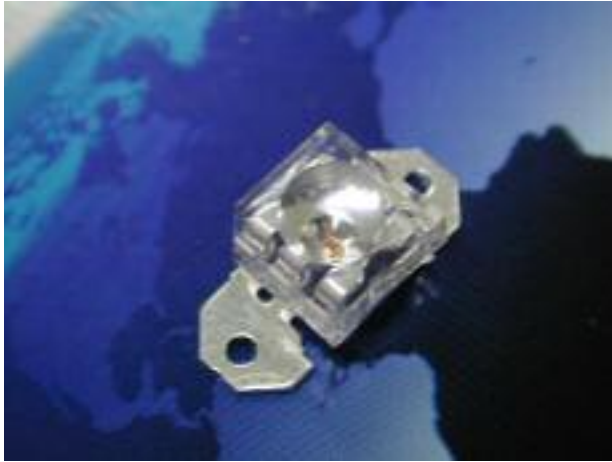

## Technical Data

### Features

- \* HIGH LUMINANCE OUTPUT.
- \* DESIGN FOR HIGH CURRENT OPERATION.
- \* SOLDERLESS MOUNTING TECHNIQUE.
- \* LOW POWER CONSUMPTION.
- \* LOW THERMAL RESISTANCE.
- \* LOW PROFILE.
- \* PACKAGED IN TUBES FOR USE WITH AUTOMATIC INSERTION EQUIPMENT.
- \* RoHS COMPLIANT.

### Benefits

- \*Rugged Lighting Products.
- \*Electricity savings.
- \*Maintenance savings.
- \*Environmental Conformance.

### Typical Applications

- \*Automotive Exterior Lighting.
- \*Solid State Lighting and Signaling.

## Outline Drawings

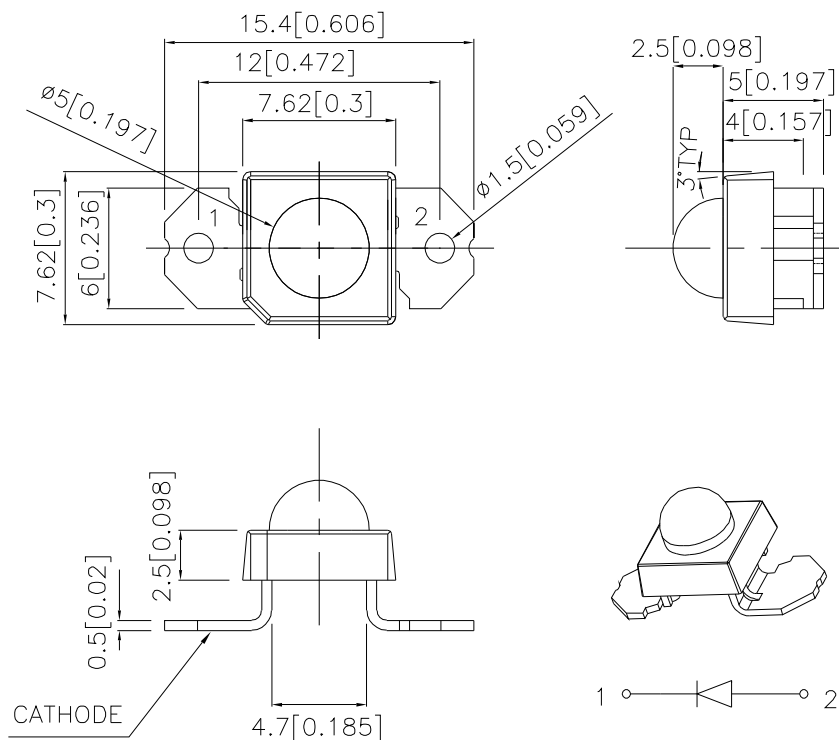

**Notes:**

1. All dimensions are in millimeters (inches).
2. Tolerance is  $\pm 0.25(0.01")$  unless otherwise noted.
3. Lead spacing is measured where the leads emerge from the package.
4. Specifications are subject to change without notice.

### Absolute Maximum Ratings at $T_A=25^\circ\text{C}$

PARAMETER	SUR-G	UNITS
DC Forward Current	70	mA
Power dissipation	160	mW
Reverse Voltage	5	V
Operating Temperature	-40 To +85	$^\circ\text{C}$
Storage Temperature	-55 To +85	$^\circ\text{C}$

## Selection Guide

Part No.	LED COLOR	Iv(cd) <sup>[1]</sup> @ 70mA		Viewing Angle <sup>[2]</sup>
		MIN.	TYP.	2θ1/2 Typ.
L-7701C4SURC-G	HYPER RED (InGaAlP)	2.8	4.1	50°

Notes:

- 1.Luminous intensity is measured with an integrating sphere after the device has stabilized.
- 2.θ1/2 is the angle from optical centerline where the luminous intensity is 1/2 the optical centerline value.

## Optical Characteristics at TA=25°C

IF=70mA Rθj-a=200°C/W

DEVICE TYPE	PEAK WAVELENGTH λPEAK (nm) TYP.	DOMINANT <sup>[1]</sup> WAVELENGTH λDOM (nm) TYP.	SPECTRAL LINE WAVELENGTH Δλ1/2(nm) TYP.
L-7701C4SURC-G	640	630	22

Note:

- 1.The dominant wavelength is derived from the CIE Chromaticity Diagram and represents the perceived color of the device.

## Electrical Characteristics at TA=25°C

DEVICE TYPE	FORWARD VOLTAGE VF(VOLTS) @ IF=70mA			REVERSE CURRENT IR (uA) @ VR=5V	CAPACITANCE C (pF) @ VF=0V F=1MHZ	THERMAL RESISTANCE Rθj-pin °C/W
	MIN.	TYP.	MAX.	MAX.	TYP.	TYP.
L-7701C4SURC-G	1.9	2.2	2.5	10	45	125

## Figures

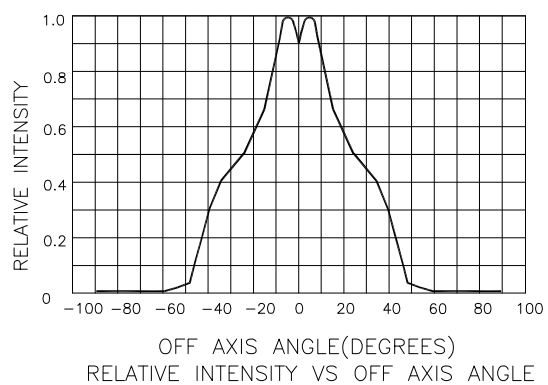
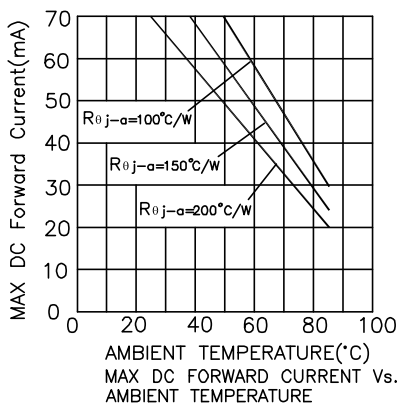
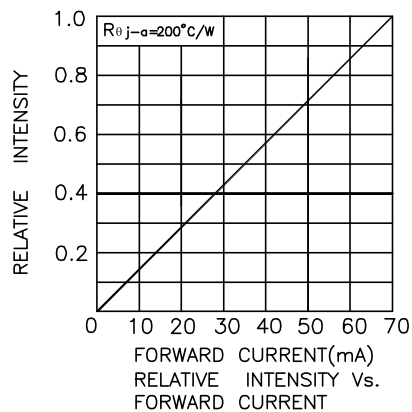
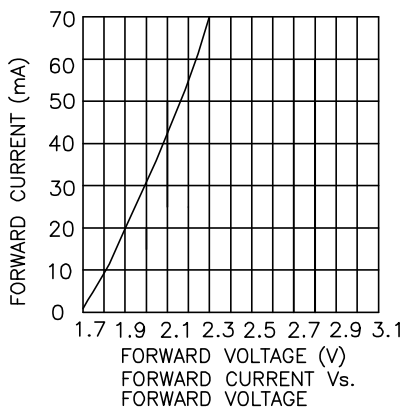
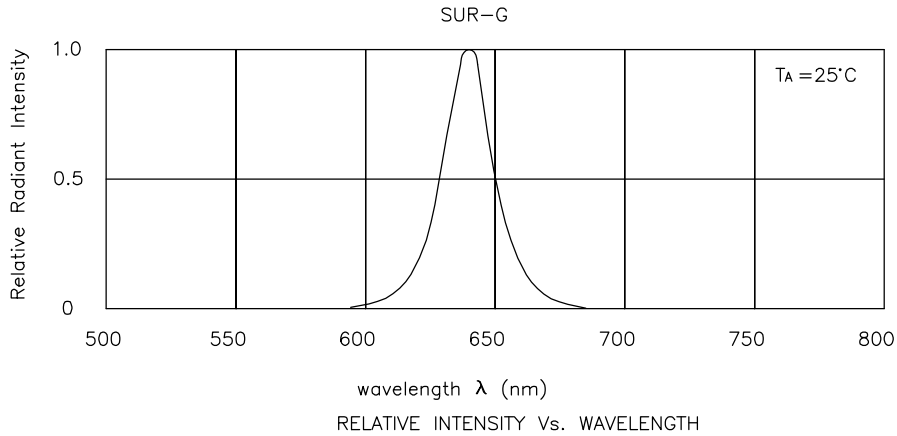

### Remarks:

If there is sorting requirement (eg. forward voltage, luminous intensity or wavelength), the condition as follows:

- 1.Wavelength: +/-1nm (Test condition is based on the sorting standard).
- 2.Luminous intensity: +/-15% (Test condition is based on the sorting standard).
- 3.Forward voltage: +/-0.1V (Test condition is based on the sorting standard).