

PRELIMINARY SPEC

L-7679C1SEC-H

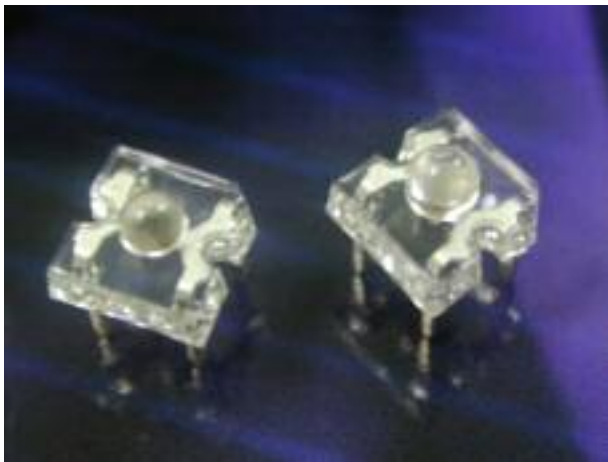

### Technical Data

#### Features:

- \*High Luminance output.
- \*Design for High Current Operation.
- \*Uniform Color.
- \*Low Power Consumption.
- \*Low Thermal Resistance.
- \*Low Profile.
- \*Packaged in tubes for use with automatic insertion equipment.
- \*RoHS Compliant.

#### Benefits:

- \*Outstanding Material Efficiency.
- \*Electricity savings.
- \*Maintenance savings.
- \*Reliable and Rugged.

#### Typical Applications:

- \*Automotive Exterior Lighting.
- \*Electronic Signs and Signals.
- \*Specialty Lighting.

## Outline Drawings

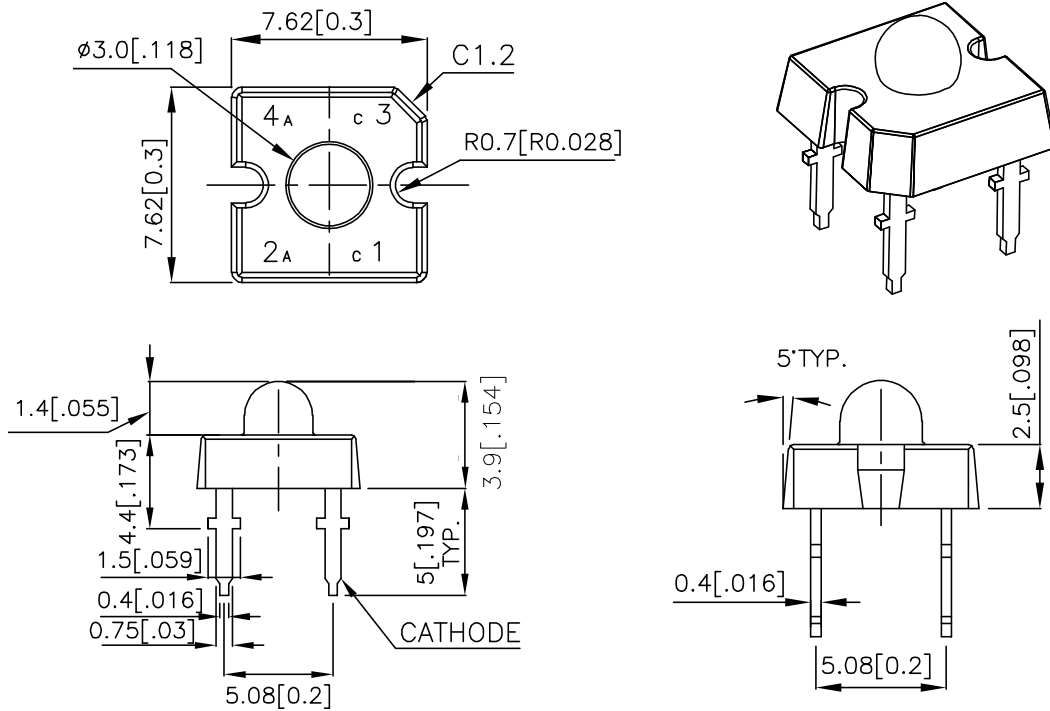

**Notes:**

1. All dimensions are in millimeters (inches).
2. Tolerance is  $\pm 0.25$  (0.01") unless otherwise noted.
3. Lead spacing is measured where the leads emerge from the package.
4. Specifications are subject to change without notice.

### Absolute Maximum Ratings at $T_A=25^\circ\text{C}$

PARAMETER	SE-H	UNITS
DC Forward Current <sup>[1]</sup>	70	mA
Power dissipation	217	mW
Reverse Voltage	5	V
Operating Temperature	-40 To +85	$^\circ\text{C}$
Storage Temperature	-55 To +85	$^\circ\text{C}$
Lead Solder Temperature <sup>[2]</sup>	260 $^\circ\text{C}$ For 5 Seconds	

1. Derate as shown in Figures 4.

2. 1.5mm [0.06inch] below seating plane.

## Selection Guide

Part No.	LED COLOR	Iv(cd) <sup>[1]</sup> @ 70mA		Viewing Angle <sup>[2]</sup>
		Min.	Typ.	2θ1/2 Typ.
L-7679C1SEC-H	TS InGaAlP ORANGE	6.5	8.0	70°

Notes:

- 1.Luminous intensity is measured with an integrating sphere after the device has stabilized.
- 2.θ1/2 is the angle from optical centerline where the luminous intensity is 1/2 the optical centerline value.

## Optical Characteristics at TA=25°C

IF=70mA Rθj-a=200°C/W

DEVICE TYPE	PEAK WAVELENGTH λPEAK (nm) TYP.	DOMINANT <sup>[1]</sup> WAVELENGTH λDOM (nm) TYP.	SPECTRAL LINE WAVELENGTH Δλ1/2(nm) TYP.
SE-H	640	630	25

NOTE:

- 1.The dominant wavelength is derived from the CIE Chromaticity Diagram and represents the perceived color of the device.

## Electrical Characteristics at TA=25°C

DEVICE TYPE	FORWARD VOLTAGE VF(VOLTS) @ IF=70mA			REVERSE CURRENT IR (uA) @ VR=5V	CAPACITANCE C (pF) @ VF=0V F=1MHZ	THERMAL RESISTANCE Rθj-pin °C/W
	MIN.	TYP.	MAX.	MAX.	TYP.	TYP.
SE-H	2.6	2.8	3.1	10	27	125

## Figures

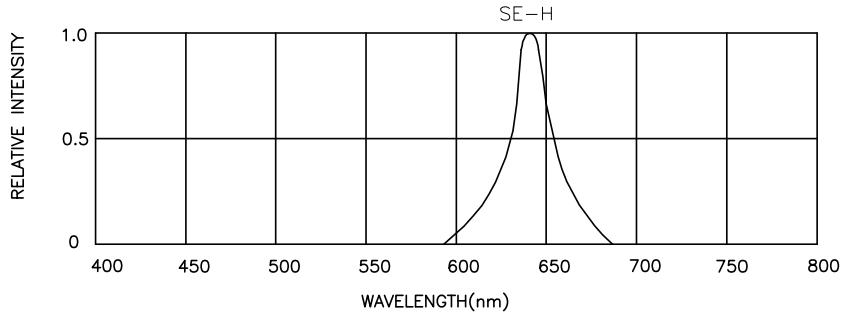

Figure1: RELATIVE INTENSITY VS. WAVELENGTH

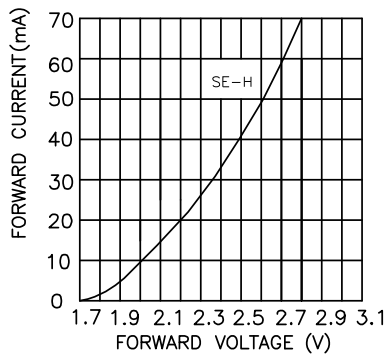

Figure2: FORWARD CURRENT Vs. FORWARD VOLTAGE

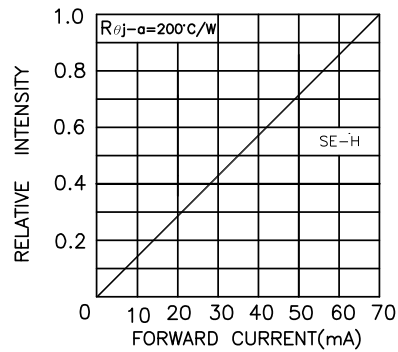

Figure3: RELATIVE INTENSITY Vs. FORWARD CURRENT

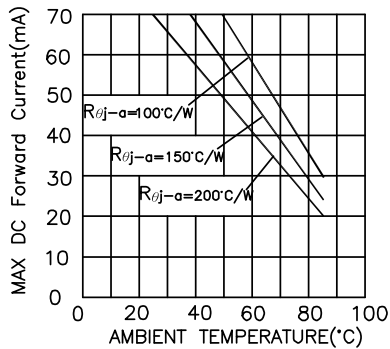

Figure4: SE-H MAX DC FORWARD CURRENT Vs AMBIENT TEMPERATURE

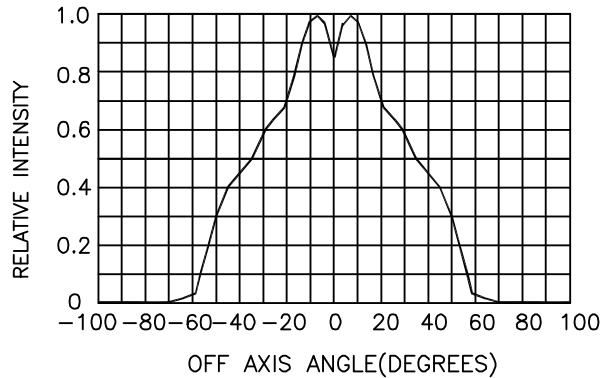

Figure5: L-7679C1SEC-H RELATIVE INTENSITY VS OFF AXIS ANGLE

### Remarks:

If special sorting is required (e.g. binning based on forward voltage, luminous intensity, or wavelength), the typical accuracy of the sorting process is as follows:

1. Wavelength: +/-1nm
2. Luminous Intensity: +/-15%
3. Forward Voltage: +/-0.1V

Note: Accuracy may depend on the sorting parameters.