

20mm LIGHT BAR

DLA/6

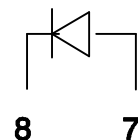
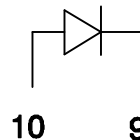
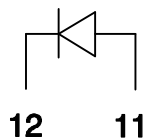
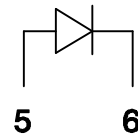
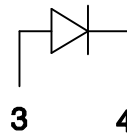
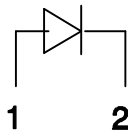
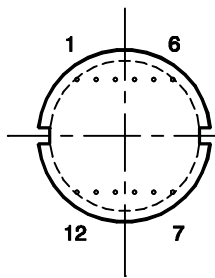
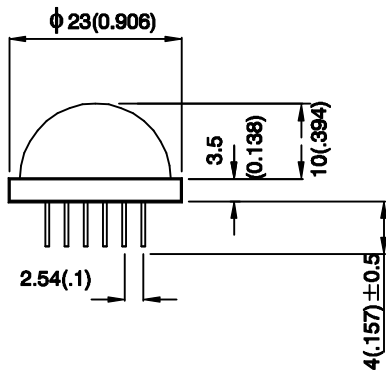
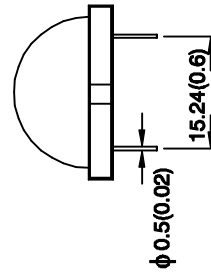
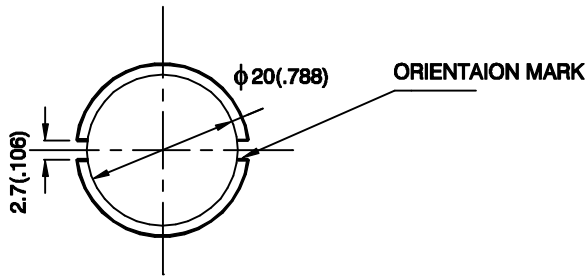

- NOTES :
 1.All dimensions are in millimeters(inches)
 2.Tolerance is $\pm 0.25\text{mm}(0.01\text{'})$ unless otherwise noted.

APPROVED:

CHECKED:

DRAWN :

SCALE :

DATA NO. : E1027

3 : 1

DATE : APR/23/98